

VAASA 70W

Code: LCV0732FNS1TG-01

TECHNICAL SPECIFICATION

Light source	High brightness LED
Color rendering index	> 70
Luminaire luminous flux	5600lm [average]
Power consumption	up to 70W
Power factor	>0.9
Operation temperature	-30°C ~ 50°C
LPW@Tj25°C	79 lm/w average(6000/6100K)
Light distribution pattern	as customer requests
Long lifetime LED	> 50,000 hours

IP Degree

IP 67

No UV or IR light radiation
Special batwing and bisymmetrical light pattern
Optimized heat fins with artistic design
110V/240V input Voltage



FEATURE & DIMENSION

Min. 96 mm
Max. 97 mm

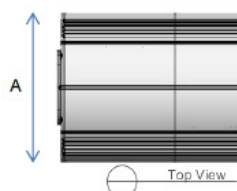
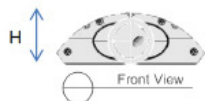

Min. 283 mm
Max. 284 mm

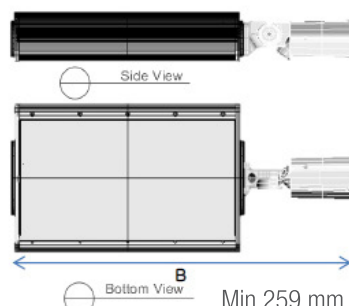

Min. 259 mm
Max. 261 mm

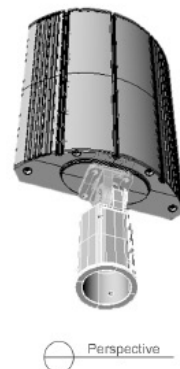

ARM TYPE

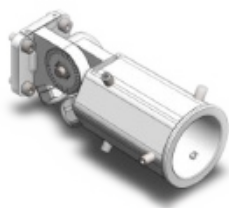

[APO - 04 - T]

PHOTOMETRIC CHARACTERISTIC

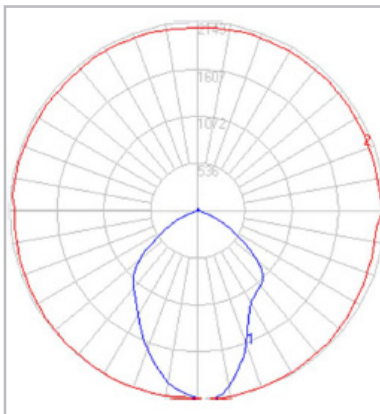

Light distribution pattern

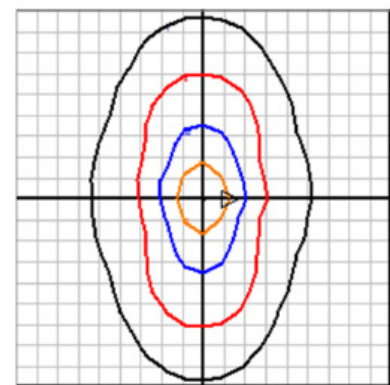

Illuminance iso-line



APPLICATION



Be replacing the existing light such as sodium lamps(30W, 70W) with LED guard light, Vaasa, 50% energy saving and fivefold increased lifespan are achieved.

Application

- Public roadways
- City Streets
- Parks
- Walkways
- Car Parks

PRODUCT NUMBER

LCV 07 36 FN S 1T G - 01

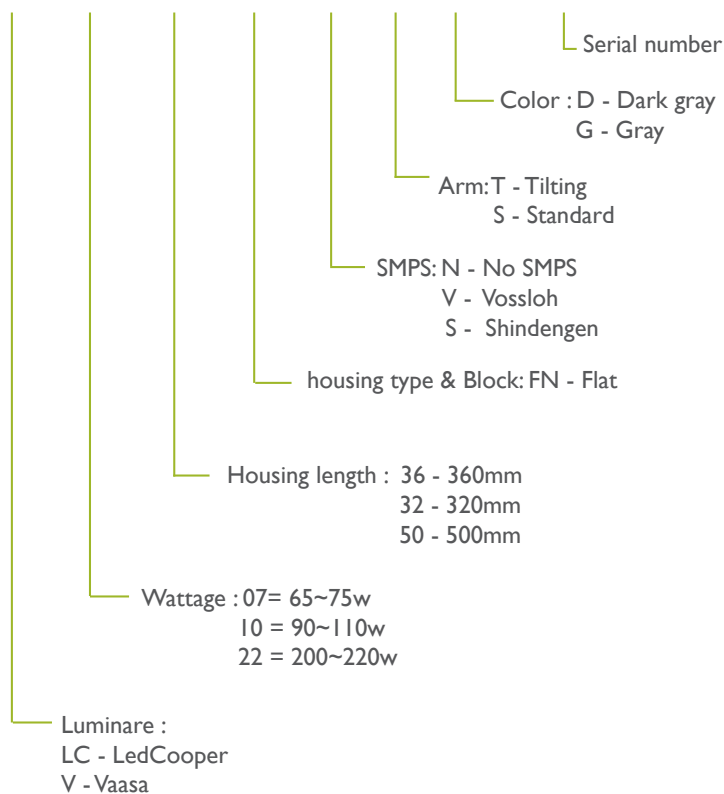

VAASA 70W

Code: LCV0732FNS1TG-01



CERTIFICATIONS

INTERNATIONAL

TUV ATTESTATION

Attestation No. 09 PELCE 00004/03TIC

ATTESTATION OF CONFORMITY

WE HEREBY DECLARE THAT THE PRODUCT

LED STREET LIGHT

RATED:

INPUT (70W) : AC230-240V, 50/60Hz

OUTPUT (100W) : 120/277V, 50/60Hz, 4A

OUTPUT 2 : DC24V, 4.1A, 100W

MODEL:

Maalestrom

APPLICANT:

AMO Co., Ltd.

#185-1, Sucham-ri, Tongjin-eup, Gimpo-si, Kyonggi, Korea

IS IN COMPLIANCE WITH THE REQUIREMENTS OF THE STANDARDS

EN 55015:2006

EN 61547:1995+A1:2000

EN 61000-3-3:1995+A1:2001+A2:2005

AS RESULT OF THE TEST IN OUR APPOINTED LABORATORY

ERI (EMC RESEARCH INSTITUTE)

CE

TUV INTERCERT

An Street Bogen 2, D-59271 Bielefeld, 01.10.2008

TUV

EC Declaration of Conformity

Ref No.: SLB-10-0255

Product: LED Lamp

Model(s): SODIX RW

Manufacturer: AMOLUXE CO., LTD.

(Factory): 579-10, Manho-Ri, Posong-Eup, Pyeongtaek-Si, Gyeonggi-Do, KOREA

Harmonized Standard: EN 60968-1999 + A1:1993 + A2:1999 used in conjunction with EN 60061-1:1993 for the lamp cap EN 61347-2-13:2006 for the equipped control gear

We herewith declare,

that this product complies with the appropriate basic safety and health requirements of the EC Directive based on its design and type, as brought into circulation by us. In case of alteration of this equipment, not agreed upon by us, this declaration will become invalid.

Date: March 15, 2010

according to Low Voltage Directive 2006/95/EC

Signature: *Xin Fu Yang / President*

CE

CE

UL the standard in safety

File: E99732 Vol 1

Issue: 2010-11-05

Revision: 2003-02-05

POWER-UP SERVICE PROGRAM (TYPE 1)

LIGHT-EMITTING-DIODE STREET-BUSINESS LUMINAIRE (TYPE 1) (TYPE 1) (TYPE 1)

Manufacturer: AMOLUXE CO LTD

(ADDRESS): 185-1, SŪCHAM-RŪ, TONGJIN-EUP, GIMPO-SI, KYONGGI-DO, KOREA

Model(s): AMOLUXE CO LTD

(ADDRESS): 17-2 JAMHŪN-DONG, SEONGBU-GU, SEOUL, SŪP'ŪN-KŪN DO, KOREA

(Address): 5995 AS AVENUE (ADDRESS): 640

This Procedure authorizes the above manufacturer to use the marking specified by Underwriters Laboratories Inc., Ltd. or any authorized licensee of UL only on products covered by this Procedure, in accordance with the applicable UL Evaluation Agreement.

The prescribed Mark or Marking shall be used only at the above manufacturing location or such products which comply with this procedure and any other applicable requirements.

The Procedure contains information for the use of the above named Manufacturer and representatives of Underwriters Laboratories, Inc. and is not to be used for any other purpose. It is sold to the Manufacturer with the understanding that it is not to be copied, altered, copied or in part, and that it will be returned to UNDERWRITERS LABORATORIES, INC. in its or any authorized licensee of UL, upon request.

THE PROCEDURE, and any subsequent revision, is the property of Underwriters Laboratories Inc. (UL) and the authorized licensee of UL and is not transferable.

Underwriters Laboratories Inc.

Signature: *William R. Carney*

Signature: *William R. Carney*

Signature: *William R. Carney*

Signature: *William R. Carney*

UL

NATIONAL

CERTIFICADO DE APROBACIÓN DE TIPO

E-008-01-17675

Notificado por la Superintendencia de Electricidad y Combustibles, según Resolución N° 958, de fecha 01 de Abril de 2011.

N° Certificado SEC: 42749

Fecha de Emisión del Certificado: 27/03/2012

N° y Fecha de Solicitud de Certificación: E-008-01-27775 de fecha 19/04/2012

Procedimiento de Análisis y Emisión: PR N° 5007

Normas Técnicas de Certificación: IEC 60561-2:2002; IEC 60068-1:2008; IEC 60529:2001

Nombre del Solicitante de Certificación: SERVICIO DE INGENIERIA Y CONSTRUCCIONES SINTAC S.A.

Dirección del Solicitante: Avenida Las Torres, Providencia - Santiago

Declaración de Ingreso al Sistema Nacional de Aduana (SNA): No aplica

1- IDENTIFICACIÓN DEL PRODUCTO

1.1 Descripción Técnica del Producto: Luminaria para alumbrado público

1.2 Marca: AMOLUXE

1.3 Modelo o Tipo: Maalestrom

1.4 Características Técnicas: 220-240V~50/60Hz / Class II / IP 67

1.5.1 Potencias nominales: 100W

1.5.2 Fuente de luz: Módulos LED

1.5.3 Método de instalación: Sobre un trazo de una columna o poste

1.5.4 Altura de montaje: Mín. 4m - Máx. 11m

1.6 Identificación por Traceabilidad: SVA 1003

1.7 País de origen: COREA

1.8 Provisión: COREA

1.9 Termino de la muestra: 1 unidad

1.10 Nombre del Fabricante: AMOLUXE

1.11 Dirección del Fabricante: 17-2 Jamsil-Dong Seocho-Gu, Seoul, Korea

2- OTROS ANTECEDENTES

2.1 Nombre del Laboratorio donde se ejecutaron los ensayos: CESMEC S.A.

2.2 N° de informe de ensayo: SCE-2012P

NOTA: ELABORADO AUSENTE DE LA PRESENIA DEL REPRESENTANTE DEL FABRICANTE EN EL MOMENTO DE LA EMISIÓN DEL CERTIFICADO Y DE ACUERDO A LA LEY Y DE ACUERDO AL PROCEDIMIENTO

FECHA: 03 FEB 2012

DILIGENCIA NOTARIAL AL DOSSIER

CESMEC (1 DE 2)

CERTIFICADO DE APROBACIÓN DE TIPO

E-008-01-17675

3- USOS DEL PRODUCTO

3.1 Clasificación según las condiciones de empleo (uso): Para iluminación exterior pública normal

3.2 Clasificación según el material de la superficie de apoyo, para la que está prevista la Luminaria: Luminaria fija adecuada para el montaje solo sobre superficies incombustibles no inflamables.

4- APROBACIÓN Y VIGENCIA

En atención a los resultados obtenidos en los ensayos y pruebas efectuadas, se otorga el presente Certificado de Tipo, de acuerdo a las disposiciones legales, reglamentarias y normativas vigentes.

NOTA: CUANDO AUSENTE O, COMO EN LA PRESENTE, FALTARE EL REPRESENTANTE DEL FABRICANTE EN EL MOMENTO DE LA EMISIÓN DEL CERTIFICADO Y DE ACUERDO A LA LEY Y DE ACUERDO AL PROCEDIMIENTO

FECHA: 03 FEB 2012

DILIGENCIA NOTARIAL AL DOSSIER

CESMEC (2 DE 2)